

THERMAL, ELECTRIC JET ENGINES AND POWER PLANTS OF AIRCRAFTS

THERMAL HYDRAULIC EFFICIENCY OF COPLANAR COOLING CHANNELS FOR LIQUID ROCKET ENGINE CHAMBERS

V.P. Alexandrenkov

Bauman Moscow State Technical University, Moscow, Russian Federation
e-mail: aleks@power.bmstu.ru

The paper considers the coplanar circuits (with cross finning) used for cooling liquid rocket engines by means of the maximal heat removal criterion. The available experimental data on the convective component of heat loss are used to perform computational and analytical analysis of the influence of both thermal hydraulic flow characteristics and finning parameters on their efficiency. The possibility of using the proposed methodology for evaluating the heat transfer efficiency in the conventional finned circuits with regard to the coplanar flow peculiarities is demonstrated. The domains of finning parameters are defined with a significantly higher (2–4 times) efficiency in comparison with the conventional finning of the cooling channels.

Keywords: circular coplanar channel, cross-finning, convective heat transfer intensification, efficiency, maximal heat removal, finning parameters, thermal hydraulic characteristics.

Cooling channels of liquid rocket engines (LRE) chambers are circular channels formed by two shells joined with finning. As demonstrated in [1] the finning factor significantly affects the efficiency of the firewall cooling. It was also found out that under certain conditions the finning factor can lead to negative results, i.e. lower heat removal as compared to the reference smooth channel without heat transfer intensification (HTI). Therefore, the heat transfer intensification of the convective component is a critical problem in terms of an additional or countervailing measure, which can considerably increase the heat removal from the firewall in order to achieve the required cooling conditions.

Taking into account the finning scale and technological constraints, the well-known conventional methods of HTI such as “artificial roughness” are quite limited in use.

The method of heat and mass transfer intensification in the circular finned channels, so called the vortex or coplanar method, is described and analyzed in [2, 3]. A coplanar channel (CC) (Fig. 1) is an innovative structure of joined shells and cross fins on the opposite surfaces of the circular channel enabling the cross flow of a heat transfer agent.

This design solution is a special type of the classic finned channel with additional geometric parameters and the obvious specific nature of both heat and mass transfer mechanisms and their calculation.

The model of physical flow in such a channel is a combination of individual coplanar vortex flows formed by cross finning due to viscous

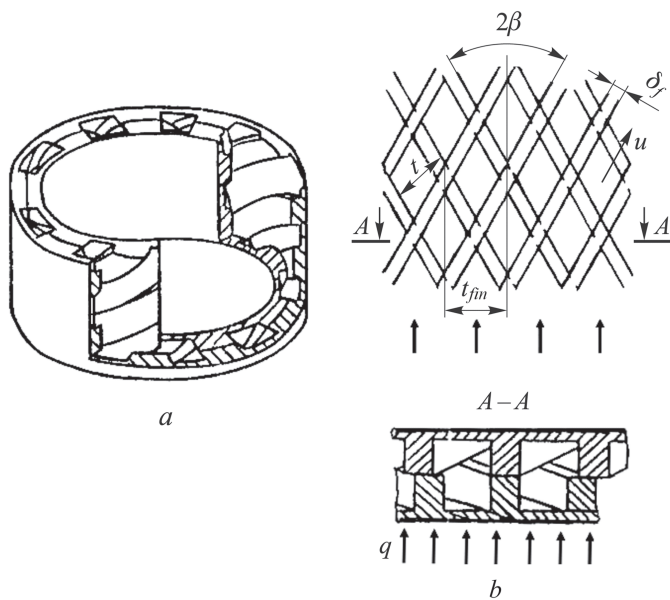

Fig. 1. Coplanar channel:

a – is a channel general arrangement; *b* – is a channel-developed view

forces in the interfin channels on the opposite sides of the circuit. Oppositely directed cross-vortex flows interact through the mixing layer.

In the layer of cross flows mixing, continuous deformation and transformation of the interacting flows boundary layers occur that determine the complex pattern of their interaction mechanisms accompanied by an impulse, heat, and mass transfer.

The heat transfer intensification in this channel is determined by a combination of several interaction mechanisms, such as a generation of turbulent pulses in the mixing layer and their transfer by a vortex flow onto the exposed surface of the interfin channels; a substitution of hot layers of a heat agent near the heat-release surfaces with colder layers of the opposite periphery flows.

The experimental analysis of CC thermal hydraulic characteristics (THC) was conducted under the following conditions. The fins angles were both symmetrical and nonsymmetrical within the range of the total angle $2\beta = 45 \dots 120^\circ$, the fins height on the heat-release surface h_1 constituted a half of the channel height h . The profile of the interfin channels characterized by the fin height to the channel width ratio $\chi = h_1/a$ was symmetrical and asymmetrical in the range of $\chi = 0.25 \dots 1.1$, and the range of the relative fin pitch ratio $\bar{t} = t/\delta_f$ on the heat removing surface constituted $2.36 \dots 7.00$, the range of flow modes was $Re = 10^3 \dots 6 \cdot 10^4$. There was a low fin density across the tops, which resulted in heat transfer into the adjacent fins approaching zero.

The analyses defined that the determining factors for CC thermal hydraulic characteristics were a flow mode parameter (Reynolds numbers) and the fin-crossing angle 2β , while the pitch ratio and the fin angles asymmetry proved to be insignificant.

When the tests were conducted and the results were processed, the following type approximating equations were obtained for THC. The convective heat transfer rate (i.e. minus finning contribution to the effective heat transfer) takes the form:

$$St = \exp(-2.47 + 0.81\beta) Re^{-0.32} Pr^{-0.6}$$

or

$$Nu = e^{(-2.47+0.81\beta)} Re^{0.68} Pr^{0.4},$$

a hydraulic drag coefficient can be written as:

$$\xi = e^{(5.24+2.94\beta)} Re^{-1.32} + e^{(-4.7+3.46\beta)},$$

where $Re = (\rho u d_e) / \mu$ is the Reynolds number; $Pr = \mu c_p / \lambda$ is the Prandtl number; β is a half of the fins crossing angle (2β); u is the mass average flow velocity in the interfin channels; d_e is the equivalent hydraulic diameter of the interfin channels. The coolant properties were determined by the mass average flow temperature in SI system, rad.

Relative thermal hydraulic characteristics for CC can be obtained by comparing them with characteristics of the reference smooth circular channel with compatible values of the Re and Pr numbers.

The reference channel characteristics can be presented by the following dependencies [5]:

$$Nu_{sm} = 0.021 Re^{0.8} Pr^{0.43}$$

— is a convective heat transfer coefficient,

$$\xi_{sm} = 0.348 Re^{-0.25}$$

— is a hydraulic drag coefficient, where the similarity numbers Re and Nu are determined by means of the equivalent hydraulic diameter of the circular channel $d_{sm} = 2h$ and the mass average velocity. Thermal physical properties of the coolant are determined by the mass average flow temperature in SI system.

The processing results for relative THC are presented in Fig. 2, where $\eta_{Nu} = \left(\frac{Nu Pr^{-0.4}}{Nu_{sm} Pr_{sm}^{-0.4}} \right)_{Re}$; $\eta_{\xi} = (\xi / \xi_{sm})_{Re}$.

The analysis of the results indicates that with the fins crossing angle β increasing, the level of relative THC grows significantly. Moreover,

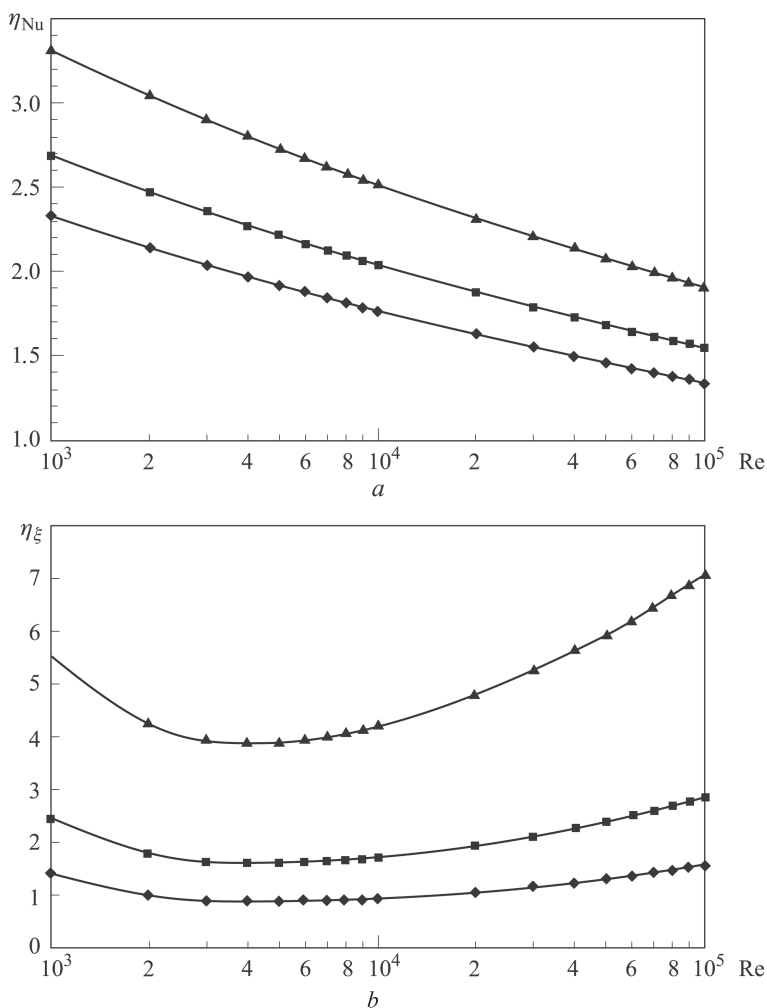

Fig. 2. Relative thermal hydraulic characteristics of CC at various angles β (\blacklozenge – 20° ; \blacksquare – 30° ; \blacktriangle – 45°):
 a – is a thermal characteristic, b – is a hydraulic characteristic

with the Re number growing, η_{Nu} characteristic decreases monotonically, which signifies a gradual degeneracy of the convective heat transfer intensification. The relative hydraulic characteristic η_ξ has a tendency towards the optimum (min) in the laminar to the turbulent flow transition zone. The peculiar feature of these characteristics is the fact that the heat transfer intensification rate exceeds the hydraulic drag increase rate in the area of a transition mode and moderate crossing angles. However, at $\beta = 35 \dots 45^\circ$ an increase in η_ξ is faster than in η_{Nu} (Fig. 3).

On the assumption that CC is a special design type of the circular finned channel, its efficiency evaluation can be performed on the basis of the methodology previously suggested [1]. It states that the maximum heat transfer efficiency of the circular finned cooling channels can be calculated

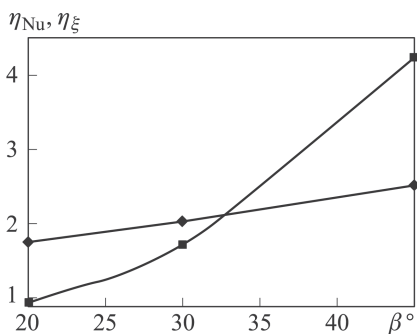

Fig. 3. Dependency of relative THC on the angle β at $Re = 10^5$:

■ – η_ξ ; ◆ – η_{Nu}

using the formula

$$K_Q = K_{Q_0} A^*,$$

where $K_{Q_0} = \eta_{Nu} \eta_\xi^{-1/3} K_{\Delta p} (K_m / k_D)^{\frac{3n-2-m}{3}}$ is HTI efficiency with regard to a convective component in the circular non-finned channel ($k_D = \frac{D_1 + h}{D_1 + h_{sm}}$ is the mean diameter correction factor, $K_{\Delta p}$, K_m are congruence conditions); $A^* = A_f \eta_f$ is the finning thermal geometric factor (A_f is a channel finning geometric parameter, η_f is a finning efficiency coefficient).

All other conditions being equal, i.e. when hydraulic pressure losses and coolant consumption are equal ($K_{\Delta p}$ and K_m equal unity), the efficiency criterion K_{Q_0} will be determined mostly by the power-law dependence on the relative hydraulic characteristic $\eta_\xi^{-1/3}$ and the coefficient of the convective heat transfer intensification η_{Nu} .

The channel geometric parameter in case of unidirectional fins is defined by formula [1]

$$A_p = \left(\frac{\bar{t}}{(\bar{t} + \bar{h} - 1) \cos \beta} \right)^{\frac{3n-m-2}{3}},$$

where $\bar{t}_f = t/\delta_f$; $\bar{h} = h/\delta_f$; t and δ_f are the fin normal pitch and thickness; h is the fin height equalling the channel height; β is the fin tilt angle line; n and m are the power-law approximating coefficients in the equations for Nu and ξ .

Parameter A_f was obtained as a result of the relative variables transformation in both the object and the reference smooth channel. Assuming that the fin normal pitch ratios on the working (heat releasing) and the opposite (shaping) surfaces are proportional, they can be considered equal, i.e. $t_1 \approx t_2$. The channel total height h is determined by the sum of the opposite fins heights, i.e. $h = h_1 + h_2$, while the angle β can be assumed to equal a half of the fins intercrossing angle, i.e. $\beta = 0.5(2\beta)$. Thus, the parameter A_f , determined by the way of obtaining and processing the

relative THC in case of CT, can be considered an equivalent to its value for the conventional finned channels.

According to [6] the finning efficiency coefficient η_f accounts for both heat releasing surface development and fins thermal efficiency:

$$\eta_p = 1 - \frac{1}{\bar{t}} + \frac{2\bar{h}_p}{\bar{t}} \left(\frac{\text{th} \left(\frac{\bar{h}_p \sqrt{2 \text{Bi}}}{\bar{h}_p \sqrt{2 \text{Bi}}} \right)}{\bar{h}_p \sqrt{2 \text{Bi}}} \right) \xi,$$

where $\text{Bi} = \alpha \delta_f / \lambda_f$ is the Biot number; ξ is a possible heat release correction factor for the channel external wall, assumed to equal unity in real cases.

In the CC case, thermal and geometric parameters will be considered separately while calculating η_f . The heat effect is mostly generated by fins with the height h_1 located on the heat releasing surface, while the so-called forming fins (of h_2 height) on the opposite wall can operate, i.e. receive and release heat, only via the contact spots with h_1 fins. Taking into account the real ranges of the fin pitch $\bar{t} = 2.5 \dots 7$ and the height $\bar{h}_1 = 3 \dots 10$, the area and the heat transfer of these contact spots can be neglected, especially with regard to the possible contact resistance. Thus, only the height h_1 of the fins on the heat releasing surface should be considered while calculating η_f .

Apart from the fins side surface h_1 the heat release can be produced by non-contacting end surfaces, which can be accounted for with an additional coefficient ξ_{end} . Then the formula for calculating a finning coefficient will take the following form

$$\eta_p = 1 - \frac{1}{\bar{t}} + \frac{2\bar{h}_1}{\bar{t}} \frac{\text{th} \left(\frac{\bar{h}_1 \sqrt{2 \text{Bi}}}{\bar{h}_1 \sqrt{2 \text{Bi}}} \right)}{\bar{h}_1 \sqrt{2 \text{Bi}}} \xi_{end},$$

where $\bar{t} = t / \delta_{f1}$, $\bar{h}_1 = h_1 / \delta_{f1}$ are the relative values of finning parameters, i.e. the pitch and height (t, h_1), δ_{f1} is the fins thickness on the heat releasing surface.

A simple analysis can reveal that the contribution factor for the fins end surfaces can be expressed via the relative fraction of the free surface \bar{S}_f and the relative height h_1 using the following dependence

$$\xi_{end} = \left(1 + 0.5 \frac{\bar{S}_p}{h_1} \right),$$

where $\bar{S}_p = (1 - 1/\bar{t})$ is the relative fraction of the free side surface on the heat releasing wall, non-contacting with the coupled fins.

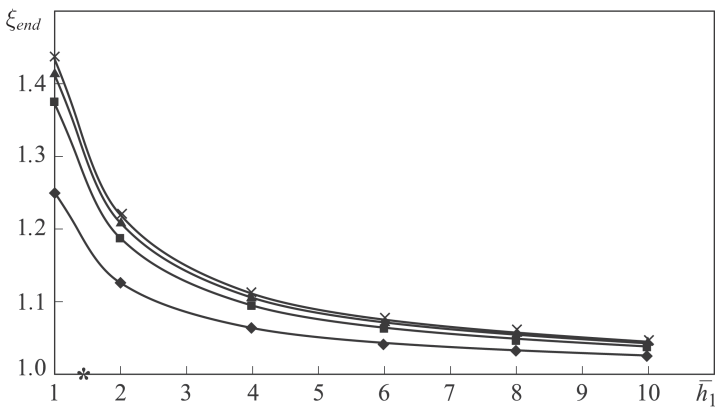

Fig. 4. Dependency of fins end surfaces contribution on finning parameters \bar{h}_1 :

◆ $-t = 2$; ■ $-t = 4$; ▲ $-t = 6$; × $-t = 8$

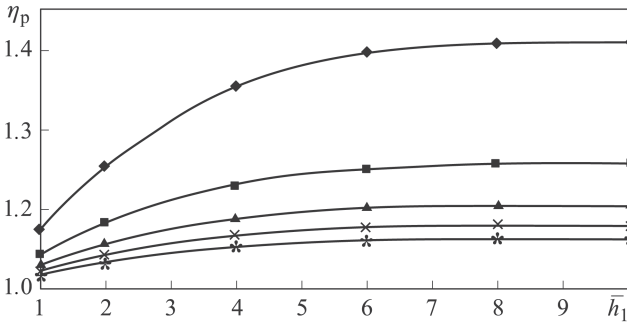

Fig. 5. Dependency of the finning coefficient η_p on CC finning parameters with accounting for the fins end surfaces at $Bi=0.04$:

◆ $-t = 2$; ■ $-t = 4$; ▲ $-t = 6$; × $-t = 8$; * $-t = 10$

The dependency of ξ_{end} coefficient on finning parameters is shown in Fig. 4.

With the account for ξ_{end} influence, the finning coefficient η_f increases markedly in the fins low height area ($\bar{h}_1 = 1 \dots 4$), then it tends to stable values while increasing simultaneously, with the pitch value growing (Fig. 5). With the Biot number increasing, the finning coefficient markedly decreases.

The pattern of change of the combined thermal geometrical parameter $A^* = A_f \eta_f$ (Fig. 6) has the following implications. As it was expected, the pattern of A^* change corresponds to the full-size finning with regards to the fins height, however, its absolute value is 15...30% lower mostly due to considering only the fins height \bar{h}_1 on the heat realing surface while calculating the finning coefficient. The maximum of its values shifts to the large-values region \bar{h}_1 , which extends the optimal finning parameters zone.

In all other cases, HTI in CC can be calculated and analysed according to the above presented methodology for the circular finned channels [1] taking into account their specific factors, parameters and features of coupled

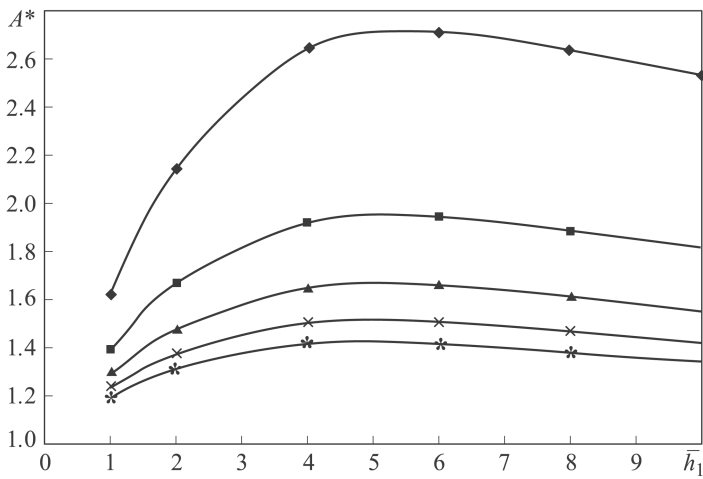

Fig. 6. Dependency of the combined thermal geometrical parameter A^* on finning parameters at $\beta = 30^\circ$ and $Bi=0.04$ (see legends in Fig. 5)

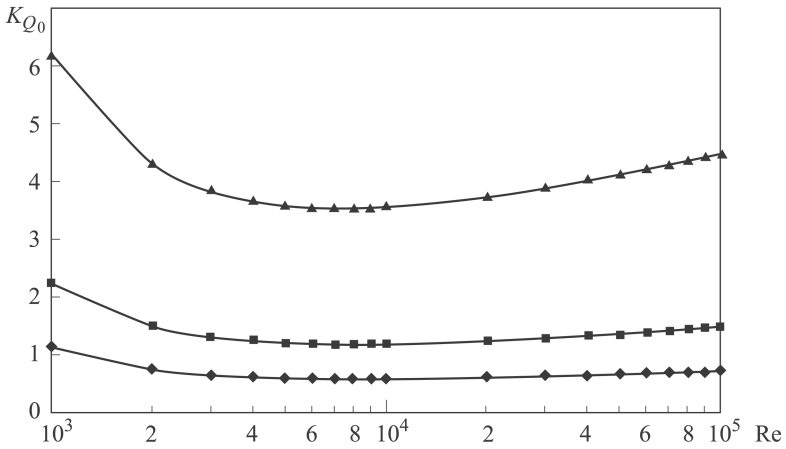

Fig. 7. Dependency of the convective component of the efficiency criterion K_{Q_0} on the flow mode for various fins crossing angles:

◆ – $\beta = 20^\circ$; ■ – $\beta = 30^\circ$; ▲ – $\beta = 45^\circ$

cross finning. Within this framework, the energy efficiency of CC for LRE chamber cooling was estimated, both numerically and analytically.

The coplanar channel efficiency with regard to the convective component K_{Q_0} (at $\beta > 30^\circ$, Fig. 7) reaches considerable values (from 1.5 to 4 and more), with the thermal geometric parameter A^* being no lower than unity within the investigated range, this can mean that the coplanar flow has a positive cooling effect in the whole recommended range of Re numbers. However, there is no efficiency at $\beta < 30^\circ$.

The final results of the efficiency estimation by the criterion K_Q confirm these expectations. It was also found out that the decisive factor for the efficiency is determined by the fins crossing angle β and the finning Biot number. Thus, when the angle β increases from 30° to 40° , K_Q increases

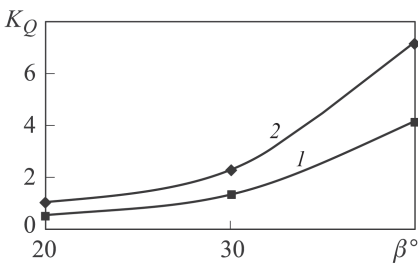

Fig. 8. Effect of the fins crossing angle on the efficiency criterion K_Q at various Biot numbers ($Re = 10^4$; $\bar{h}_1 = 4$; $\bar{t}_p = 4$): curves 1 – $Bi=0.4$; curves 2 – $Bi=0.04$

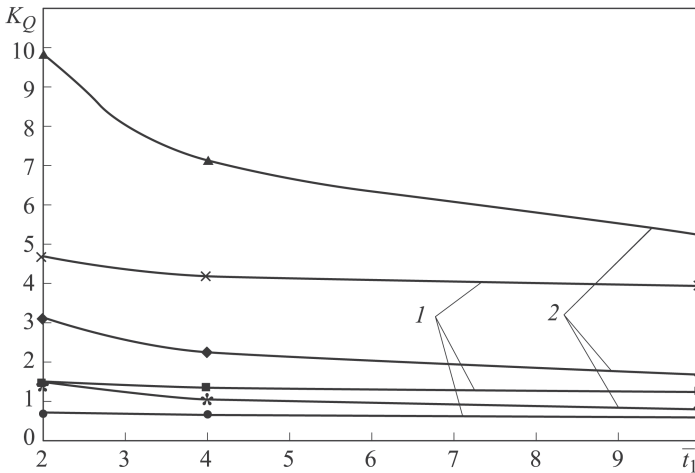

Fig. 9. Dependency of the efficiency criterion K_Q on the finning pitch at various angles and Biot numbers ($Re = 10^4$; $\bar{h}_1 = 4$): curves 1 ($Bi=0.4$) – \bullet – $\beta = 20^\circ$; \blacksquare – $\beta = 30^\circ$; \times – $\beta = 45^\circ$; curves 2 ($Bi=0.04$) – $*$ – $\beta = 20^\circ$; \blacklozenge – $\beta = 30^\circ$; \blacktriangle – $\beta = 45^\circ$

3–4-fold; when Bi decreases from 0.4 to 0.04, K_Q increases 1.7–2-fold (Fig. 8). At the same time, when β is less than $20 \dots 30^\circ$ the K_Q criterion demonstrates tenuous and inefficient values, even when the Biot number has favourable values.

When the fins are positioned with small intervals, the efficiency index K_Q can reach values from 3 to 10 units. However, as the finning pitch \bar{t} increases, the efficiency index K_Q decreases, which is particularly noticeable at low (favourable) Bi values (Fig. 9).

Both quantitative and qualitative values of β angles and Biot numbers make a significant contribution to the dependency of the efficiency K_Q on the heat releasing fins height \bar{h}_1 . For instance, in case of the favourable (optimistic) value $Bi = 0.04$ and the fins height \bar{h}_1 growing from 1 to 4, the criterion K_Q increases from 1 to 4 and nearly stabilizes afterwards. In case of the pessimistic values $Bi = 0.4$, the efficiency rate does not exceed $1.5 \dots 5.5$ units, noticeably decreases as \bar{h}_1 grows along the total range of values, with low sensitivity to the finning pitch ratio (Fig. 10). This estimation can be used to select finning parameters when designing cooling channels.

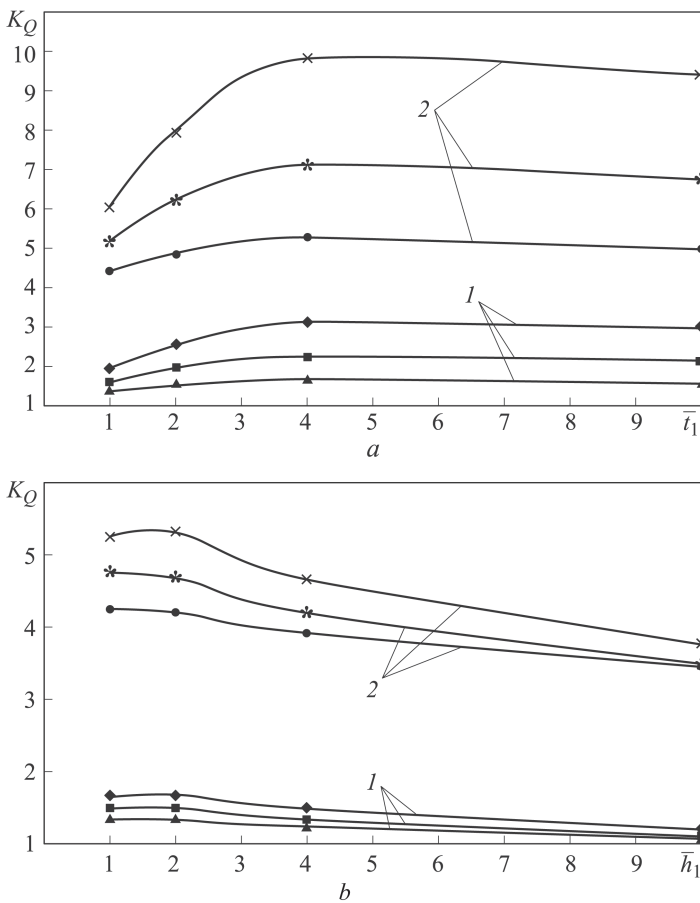

Fig. 10. Dependency of the efficiency criterion K_Q on the fins height for various angles β and finning pitch ratios \bar{t} ($Re = 10^4$):

a – are curves 1 ($\beta = 30^\circ$) – \diamond – $t = 2$; \blacksquare – $t = 4$; \blacktriangle – $t = 10$; curves 2 ($\beta = 45^\circ$) – \times – $t = 2$; $*$ – $t = 4$; \bullet – $t = 10$ at $Bi=0.04$; b – are curves 1 ($\beta = 30^\circ$) – \diamond – $t = 2$; \blacksquare – $t = 4$; \blacktriangle – $t = 10$; curves 2 ($\beta = 45^\circ$) – \times – $t = 2$; $*$ – $t = 4$; \bullet – $t = 10$ at $Bi=0.4$

The increase in the CC height as compared to the reference channel was calculated, as it is usually done for the conventional finned channel, in the following way:

$$\bar{h} = \frac{h}{h_{sm}} = \bar{h}_0 K_{hp},$$

where $\bar{h}_0 = \eta_\xi^{1/3}$ is a relative increase in the height of the non-finned channel related to the convective heat release intensification,

$$K_{hp} = (k_D \cos \beta)^{-\frac{m+2}{3}} \frac{\bar{t}}{\bar{t} - 1} \left(\frac{\bar{t} + \bar{h} - 1}{\bar{t}} \right)^{\frac{1-m}{3}}$$

is the height increase coefficient for the finned channel, here $\bar{h} = h/\delta_f = (h_1 + h_2)/\delta_f$ is determined by a sum of heat-releasing and shaping fins

heights, as the increase in the height is determined only by hydraulic losses of the whole channel, $k_D = \frac{D_1 + h}{D_1 + h_3}$ is a correcting factor for the channel mean diameter change, having little effect on the final result.

The height increase coefficient determined by finning in the turbulent flow mode ($n = 0.8$; $m = -0.25$) will constitute $K_{hf} = (k_D \cos \beta)^{-0.583} \times \bar{t}^{+0.583} (\bar{t} + \bar{h} - 1)^{0.417} / (\bar{t} - 1)$ and, as it was shown above, it can grow within the investigated range of parameters up to values 1.15...3.5, which should be taken into account when designing the chamber thermal protection.

Conclusions. By using the coplanar flows in the cooling channels, their energy efficiency will be significantly increased with regard to the firewall heat release, mostly due to the increase in the convective component as compared to the conventionally finned channels with the insufficient efficiency.

By changing such finning parameters as the fins intercrossing angle 2β , the Biot number, the relative finning pitch ratio \bar{h}_1 within the reasonable and acceptable bounds, the thermal hydraulic efficiency can be controlled, as well as the desired level of heat release and the thermal state can be achieved for the structure.

CC efficiency estimation with regard to the K_Q criterion can be based on the previously developed methodology for the classic finned channels allowing for the actual effective area of finning on the heat-releasing surface.

REFERENCES

- [1] Aleksandrenkov V.P. Efficiency of heat transfer intensification in circular finned cooling circuits of combustion chambers. *Vestn. Mosk. Gos. Tekh. Univ. im. N.E. Bauman, Mashinostr.* [Herald of the Bauman Moscow State Tech. Univ., Mech. Eng.], 2013, no. 3, pp. 111–121 (in Russ.).
- [2] Kudryavtsev V.M., Orlin S.A., Posnov S.A. Experimental research of flow resistance in circuits with coplanar channels. *Izv. Vyssh. Uchebn. Zaved., Mashinostr.* [Proc. Univ., Mech. Eng.], 1983, no. 4, pp. 54–58 (in Russ.).
- [3] Pelevin F.V., Il'inskaya O.I., Orlin S.A. Engineering application of coplanar channels. *Vestnik PNIPU. Aerokosmicheskaya tekhnika* [PNRPU Aerospace Engineering Bulletin], 2014, no. 2 (37), pp. 71–85 (in Russ.).
- [4] Orlin S.A., Posnov S.A. Experimental research of heat transfer and flow resistance in circular ducts with coplanar channels. *Trudy MVTU im. N.E. Bauman* [Proc. Bauman MSTU], 1984, no. 417, pp. 9–12 (in Russ.).
- [5] Kirillov P.L., Yur'ev Yu.S., Bobkov V.P., ed. *Spravochnik po teplogidravlicheskim raschetam. Yadernye reaktory, teploobmenniki, parogeneratory* [Reference book on thermal and hydraulic calculations. Nuclear reactors, heat exchangers, steam generators]. Moscow, Energoatomizdat Publ., 1990. 360 p.

- [6] Kudryavtsev V.M., ed. Osnovy teorii i rascheta zhidkostnykh raketnykh dvigateley [Theory and design bases of liquid propellant rocket engines]. Moscow, Vyssh. shk. Publ., 1993. 703 p.

The original manuscript was received by the editors in 24.05.2014

Contributor

Aleksandrenkov V.P. — Ph.D. (Eng.), Associate Professor, Department of Rocket Engines, Bauman Moscow State Technical University; senior researcher, Power Engineering Research Institute at Bauman Moscow State Technical University, author of over 70 publications in the fields of heat exchange processes and heat release intensification. Bauman Moscow State Technical University, 2-ya Baumanskaya ul. 5, Moscow, 105005 Russian Federation.

The translation of this article from Russian into English is done by I.R. Shafikova, a senior lecturer, Linguistics Department, Bauman Moscow State Technical University under the general editorship of N.N. Nikolaeva, Ph.D. (Philol.), Associate Professor, Linguistics Department, Bauman Moscow State Technical University.